

G-MINI ROUND HANGOVER SUSPENSION

A300626-

base number LED Dimming Finishes (Diamond) Finishes (Triangle) Finishes (Circle) Finish Options Shine Ring Beam Angle Options Cable Options

- To build a product code in our configurator select the specify button on the base model # product page
- To build a manual product code on this datasheet choose from the options listed below in blue font and add the suffix to the base model #

GENERAL

Series: G-Mini Round
 Subseries: G-Mini Round Hangover
 Partner: Prolicht
 Division: Architectural
 Installation: Suspension
 Product Type: Clusters
 Mounting Location: Ceiling
 Light Distribution: Direct

PHYSICAL

Shape: Cylinder
 Diameter (mm): 347
 Diameter (in): 13 11/16
 Height (mm): 150
 Height (in): 5 7/8
 Fixture Finish: SSR / BKV / CWI / CRY / HAB / UFT / ITA / RUA / FTG / MYG / LOD / PUS / FRO / FUP / KIA / POP / BLS / SPG / MEY / GOH / CHC / COM / ABZ / JAG / OBR / MOS / ROR
 Accent Finish: NOF / COP / MIR / SSS
 Fixture Material: Extruded Aluminum / Steel
 Cable Details: 2000mm/78 3/4" / 4000mm/157 1/2" - Cable, Black, Green, Orange, Red, White

ELECTRICAL

Lamp Type: LED (Zhaga Standard)
 Input Wattage (W): 26
 Total Output Wattage (W): 23.7
 Dimming: Tri-Mode (Non-Dimming and Phase Dimming (120Vac only) and 0-10V Dimming)
 Driver Included: Yes
 Driver Location: Integrated
 Driver Type: Constant Current - Universal
 Driver Class: Class 2
 Input Voltage (V): 120 - 277

LED

Color Temperature (°K): 2700 / 3000 / 3500 / 4000
 Max. Delivered Lumen (lm): 1614 / 1709 / 1804 / 1852
 Nominal Lumen (lm): 1840 / 1949 / 2057 / 2112
 CRI: >90 CRI
 Lamp Life (hrs): 50000

OPTICAL

Beam Angle: 20 / 26 / 56

RATINGS AND CERTIFICATIONS

Certified By: Certified for North American Standards
 IP rating: IP20



G-MINI ROUND HANGOVER SUSPENSION

A300626-

PROJECT	_____
TYPE	_____
SPECIFIER	_____
QUANTITY	_____
DATE	_____



A

G-MINI ROUND HANGOVER SUSPENSION

A300627-

base number	LED Dimming	Color Temperature	Finishes (Diamond)	Finishes (Triangle)	Finishes (Circle)	Finish Options	Shine Ring	Beam Angle Options	Cable Options
-------------	-------------	-------------------	--------------------	---------------------	-------------------	----------------	------------	--------------------	---------------

- To build a product code in our configurator select the specify button on the base model # product page
- To build a manual product code on this datasheet choose from the options listed below in blue font and add the suffix to the base model #

GENERAL

Series: G-Mini Round
 Subseries: G-Mini Round Hangover
 Partner: Prolicht
 Division: Architectural
 Installation: Suspension
 Product Type: Clusters
 Mounting Location: Ceiling
 Light Distribution: Direct

PHYSICAL

Shape: Cylinder
 Diameter (mm): 347
 Diameter (in): 13 11/16
 Height (mm): 300
 Height (in): 11 13/16
 Fixture Finish: SSR / BKV / CWI / CRY / HAB / UFT / ITA / RUA / FTG / MYG / LOD / PUS / FRO / FUP / KIA / POP / BLS / SPG / MEY / GOH / CHC / COM / ABZ / JAG / OBR / MOS / ROR
 Accent Finish: NOF / COP / MIR / SSS
 Fixture Material: Extruded Aluminum / Steel
 Cable Details: 2000mm/78 3/4" / 4000mm/157 1/2" - Cable, Black, Green, Orange, Red, White

ELECTRICAL

Lamp Type: LED (Zhaga Standard)
 Input Wattage (W): 26
 Total Output Wattage (W): 23.7
 Dimming: Tri-Mode (Non-Dimming and Phase Dimming (120Vac only) and 0-10V Dimming)
 Driver Included: Yes
 Driver Location: Integrated
 Driver Type: Constant Current - Universal
 Driver Class: Class 2
 Input Voltage (V): 120 - 277

LED

Color Temperature (°K): 2700 / 3000 / 3500 / 4000
 Max. Delivered Lumen (lm): 1614 / 1709 / 1804 / 1852
 Nominal Lumen (lm): 1840 / 1949 / 2057 / 2112
 CRI: >90 CRI
 Lamp Life (hrs): 50000

OPTICAL

Beam Angle: 20 / 26 / 56

RATINGS AND CERTIFICATIONS

Certified By: Certified for North American Standards
 IP rating: IP20



G-MINI ROUND HANGOVER SUSPENSION

A300627-

PROJECT	_____
TYPE	_____
SPECIFIER	_____
QUANTITY	_____
DATE	_____



A

G-MINI ROUND HANGOVER SUSPENSION

A300628-

base number LED Dimming Finishes (Diamond) Finishes (Triangle) Finishes (Circle) Finish Options Shine Ring Beam Angle Options Cable Options

- To build a product code in our configurator select the specify button on the base model # product page
- To build a manual product code on this datasheet choose from the options listed below in blue font and add the suffix to the base model #

GENERAL

Series: G-Mini Round
 Subseries: G-Mini Round Hangover
 Partner: Prolicht
 Division: Architectural
 Installation: Suspension
 Product Type: Clusters
 Mounting Location: Ceiling
 Light Distribution: Direct

PHYSICAL

Shape: Cylinder
 Diameter (mm): 347
 Diameter (in): 13 11/16
 Height (mm): 450
 Height (in): 17 11/16
 Fixture Finish: SSR / BKV / CWI / CRY / HAB / UFT / ITA / RUA / FTG / MYG / LOD / PUS / FRO / FUP / KIA / POP / BLS / SPG / MEY / GOH / CHC / COM / ABZ / JAG / OBR / MOS / ROR
 Accent Finish: NOF / COP / MIR / SSS
 Fixture Material: Extruded Aluminum / Steel
 Cable Details: 2000mm/78 3/4" / 4000mm/157 1/2" - Cable, Black, Green, Orange, Red, White

ELECTRICAL

Lamp Type: LED (Zhaga Standard)
 Input Wattage (W): 26
 Total Output Wattage (W): 23.7
 Dimming: Tri-Mode (Non-Dimming and Phase Dimming (120Vac only) and 0-10V Dimming)
 Driver Included: Yes
 Driver Location: Integrated
 Driver Type: Constant Current - Universal
 Driver Class: Class 2
 Input Voltage (V): 120 - 277

LED

Color Temperature (°K): 2700 / 3000 / 3500 / 4000
 Max. Delivered Lumen (lm): 1614 / 1709 / 1804 / 1852
 Nominal Lumen (lm): 1840 / 1949 / 2057 / 2112
 CRI: >90 CRI
 Lamp Life (hrs): 50000

OPTICAL

Beam Angle: 20 / 26 / 56

RATINGS AND CERTIFICATIONS

Certified By: Certified for North American Standards
 IP rating: IP20

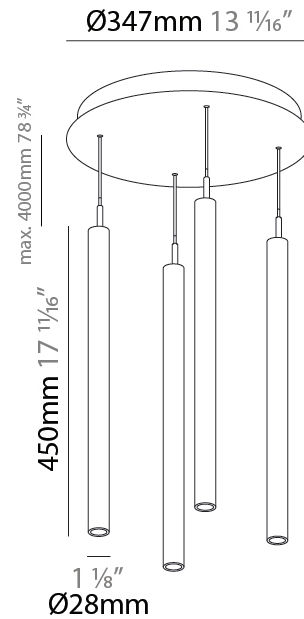
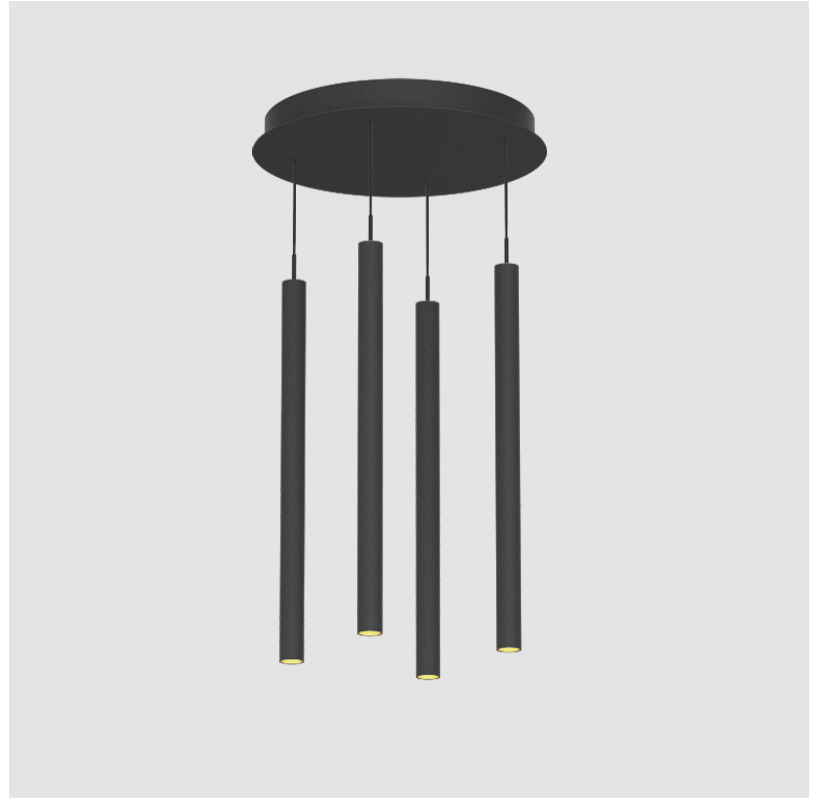

G-MINI ROUND HANGOVER SUSPENSION

A300628-

PROJECT	_____
TYPE	_____
SPECIFIER	_____
QUANTITY	_____
DATE	_____



A

G-MINI ROUND HANGOVER SUSPENSION

A300629-

base number LED Dimming Finishes (Diamond) Finishes (Triangle) Finishes (Circle) Finish Options Shine Ring Beam Angle Options Cable Options

1. To build a product code in our configurator select the specify button on the base model # product page
2. To build a manual product code on this datasheet choose from the options listed below in blue font and add the suffix to the base model #

GENERAL

Series: G-Mini Round
 Subseries: G-Mini Round Hangover
 Partner: Prolicht
 Division: Architectural
 Installation: Suspension
 Product Type: Clusters
 Mounting Location: Ceiling
 Light Distribution: Direct

PHYSICAL

Shape: Cylinder
 Diameter (mm): 347
 Diameter (in): 13 11/16
 Height (mm): 150
 Height (in): 5 7/8
 Diffuser: Shine Ring - NOR / OPL / YEL / ORA / RED / BLU / GRN
 Fixture Finish: SSR / BKV / CWI / CRY / HAB / UFT / ITA / RUA / FTG / MYG / LOD / PUS / FRO / FUP / KIA / POP / BLS / SPG / MEY / GOH / CHC / COM / ABZ / JAG / OBR / MOS / ROR
 Accent Finish: NOF / COP / MIR / SSS
 Fixture Material: Extruded Aluminum / Steel
 Cable Details: 2000mm/78 3/4" / 4000mm/157 1/2" - Cable, Black, Green, Orange, Red, White

ELECTRICAL

Lamp Type: LED (Zhaga Standard)
 Input Wattage (W): 26
 Total Output Wattage (W): 23.7
 Dimming: Non-Dimmable
 Driver Included: Yes
 Driver Location: Integrated
 Driver Type: Constant Current - Universal
 Driver Class: Class 2
 Input Voltage (V): 120 - 277

LED

Color Temperature (°K): 2700 / 3000 / 3500 / 4000
 Max. Delivered Lumen (lm): 1557 / 1421 / 1499 / 1450
 Nominal Lumen (lm): 1840 / 1949 / 2057 / 2112
 CRI: >90 CRI
 Lamp Life (hrs): 50000

OPTICAL

Beam Angle: 32 / 58

RATINGS AND CERTIFICATIONS

Certified By: Certified for North American Standards
 IP rating: IP20



G-MINI ROUND HANGOVER SUSPENSION

A300629-

PROJECT	_____
TYPE	_____
SPECIFIER	_____
QUANTITY	_____
DATE	_____



A

PROJECT	_____
TYPE	_____
SPECIFIER	_____
QUANTITY	_____
DATE	_____

G-MINI ROUND HANGOVER SUSPENSION

A300630-

base number	LED Dimming	Finishes (Diamond)	Finishes (Triangle)	Finishes (Circle)	Finish Options	Shine Ring	Beam Angle Options	Cable Options
-------------	-------------	--------------------	---------------------	-------------------	----------------	------------	--------------------	---------------

- To build a product code in our configurator select the specify button on the base model # product page
- To build a manual product code on this datasheet choose from the options listed below in blue font and add the suffix to the base model #

GENERAL

Series: G-Mini Round
Subseries: G-Mini Round Hangover
Partner: Prolicht
Division: Architectural
Installation: Suspension
Product Type: Clusters
Mounting Location: Ceiling
Light Distribution: Direct

PHYSICAL

Shape: Cylinder
Diameter (mm): 347
Diameter (in): 13 11/16
Height (mm): 300
Height (in): 11 13/16
Diffuser: Shine Ring - NOR / OPL / YEL / ORA / RED / BLU / GRN
Fixture Finish: SSR / BKV / CWI / CRY / HAB / UFT / ITA / RUA / FTG / MYG / LOD / PUS / FRO / FUP / KIA / POP / BLS / SPG / MEY / GOH / CHC / COM / ABZ / JAG / OBR / MOS / ROR
Accent Finish: NOF / COP / MIR / SSS
Fixture Material: Extruded Aluminum / Steel
Cable Details: 2000mm/78 3/4" / 4000mm/157 1/2" - Cable, Black, Green, Orange, Red, White

ELECTRICAL

Lamp Type: LED (Zhaga Standard)
Input Wattage (W): 26
Total Output Wattage (W): 23.7
Dimming: Non-Dimmable
Driver Included: Yes
Driver Location: Integrated
Driver Type: Constant Current - Universal
Driver Class: Class 2
Input Voltage (V): 120 - 277

LED

Color Temperature (°K): 2700 / 3000 / 3500 / 4000
Max. Delivered Lumen (lm): 1557 / 1421 / 1499 / 1450
Nominal Lumen (lm): 1840 / 1949 / 2057 / 2112
CRI: >90 CRI
Lamp Life (hrs): 50000

OPTICAL

Beam Angle: 32 / 58

RATINGS AND CERTIFICATIONS

Certified By: Certified for North American Standards
IP rating: IP20

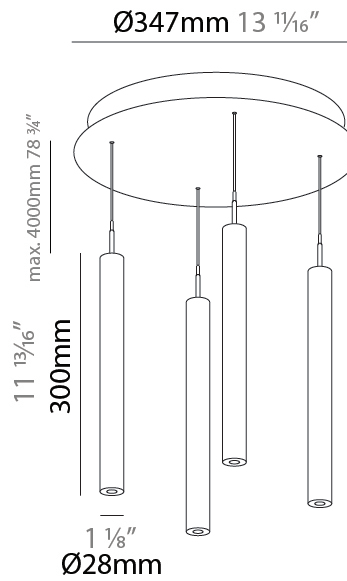

G-MINI ROUND HANGOVER SUSPENSION

A300630-

PROJECT	_____
TYPE	_____
SPECIFIER	_____
QUANTITY	_____
DATE	_____



A

G-MINI ROUND HANGOVER SUSPENSION

A300631-

base number LED Dimming Finishes (Diamond) Finishes (Triangle) Finishes (Circle) Finish Options Shine Ring Beam Angle Options Cable Options

- To build a product code in our configurator select the specify button on the base model # product page
- To build a manual product code on this datasheet choose from the options listed below in blue font and add the suffix to the base model #

GENERAL

Series: G-Mini Round
 Subseries: G-Mini Round Hangover
 Partner: Prolicht
 Division: Architectural
 Installation: Suspension
 Product Type: Clusters
 Mounting Location: Ceiling
 Light Distribution: Direct

PHYSICAL

Shape: Cylinder
 Diameter (mm): 347
 Diameter (in): 13 11/16
 Height (mm): 450
 Height (in): 17 11/16
 Diffuser: Shine Ring - NOR / OPL / YEL / ORA / RED / BLU / GRN
 Fixture Finish: SSR / BKV / CWI / CRY / HAB / UFT / ITA / RUA / FTG / MYG / LOD / PUS / FRO / FUP / KIA / POP / BLS / SPG / MEY / GOH / CHC / COM / ABZ / JAG / OBR / MOS / ROR
 Accent Finish: NOF / COP / MIR / SSS
 Fixture Material: Extruded Aluminum / Steel
 Cable Details: 2000mm/78 3/4" / 4000mm/157 1/2" - Cable, Black, Green, Orange, Red, White

ELECTRICAL

Lamp Type: LED (Zhaga Standard)
 Input Wattage (W): 26
 Total Output Wattage (W): 23.7
 Dimming: Non-Dimmable
 Driver Included: Yes
 Driver Location: Integrated
 Driver Type: Constant Current - Universal
 Driver Class: Class 2
 Input Voltage (V): 120 - 277

LED

Color Temperature (°K): 2700 / 3000 / 3500 / 4000
 Max. Delivered Lumen (lm): 1557 / 1421 / 1499 / 1450
 Nominal Lumen (lm): 1840 / 1949 / 2057 / 2112
 CRI: >90 CRI
 Lamp Life (hrs): 50000

OPTICAL

Beam Angle: 32 / 58

RATINGS AND CERTIFICATIONS

Certified By: Certified for North American Standards
 IP rating: IP20

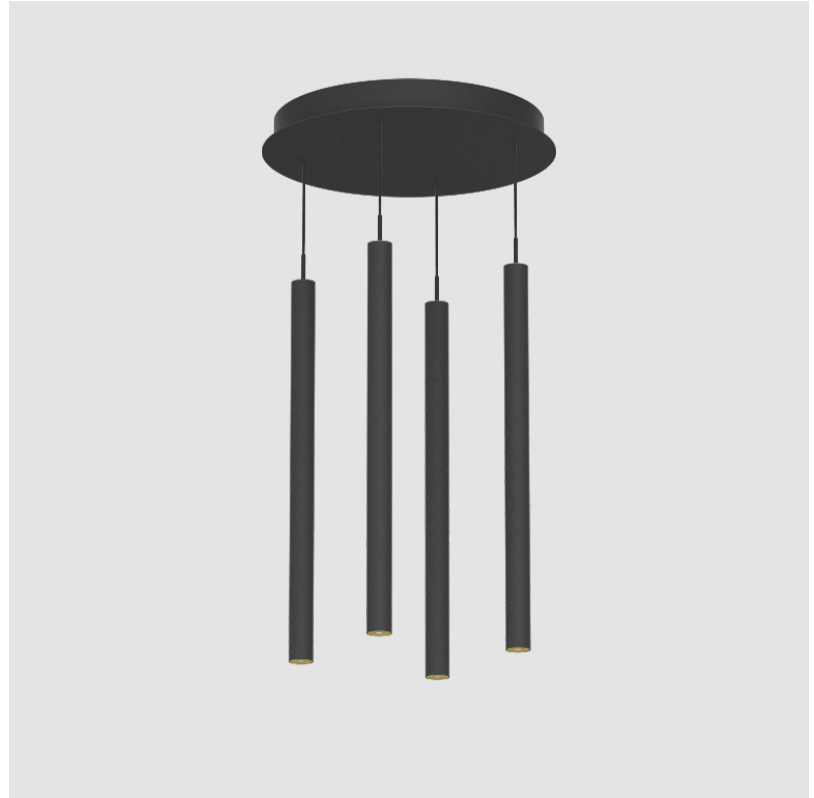

G-MINI ROUND HANGOVER SUSPENSION

A300631-

PROJECT
TYPE
SPECIFIER
QUANTITY
DATE

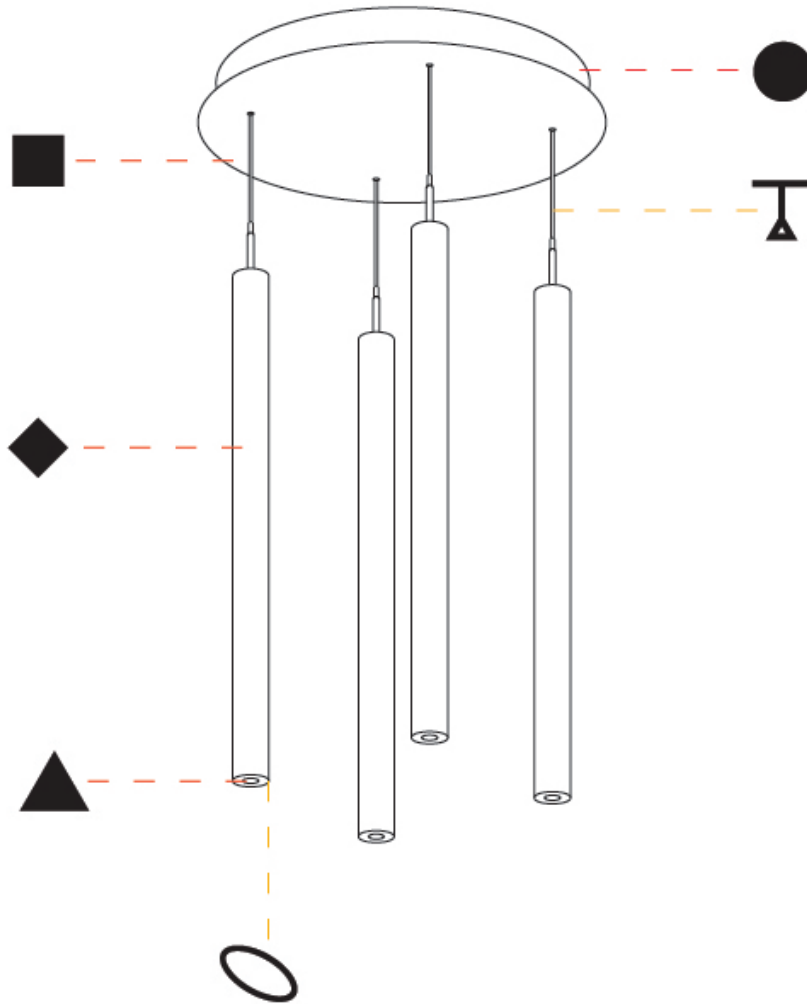

A

G-MINI ROUND HANGOVER SUSPENSION

A300632-

base number LED Dimming Finishes (Diamond) Finishes (Triangle) Finishes (Circle) Finish Options Shine Ring Beam Angle Options Cable Options

- To build a product code in our configurator select the specify button on the base model # product page
- To build a manual product code on this datasheet choose from the options listed below in blue font and add the suffix to the base model #

GENERAL

Series: G-Mini Round
 Subseries: G-Mini Round Hangover
 Partner: Prolicht
 Division: Architectural
 Installation: Suspension
 Product Type: Clusters
 Mounting Location: Ceiling
 Light Distribution: Direct

PHYSICAL

Shape: Cylinder
 Diameter (mm): 347
 Diameter (in): 13 11/16
 Height (mm): 150
 Height (in): 5 7/8
 Fixture Finish: SSR / BKV / CWI / CRY / HAB / UFT / ITA / RUA / FTG / MYG / LOD / PUS / FRO / FUP / KIA / POP / BLS / SPG / MEY / GOH / CHC / COM / ABZ / JAG / OBR / MOS / ROR
 Accent Finish: NOF / COP / MIR / SSS
 Fixture Material: Extruded Aluminum / Steel
 Cable Details: 2000mm/78 3/4" / 4000mm/157 1/2" - Cable, Black, Green, Orange, Red, White

ELECTRICAL

Lamp Type: LED (Zhaga Standard)
 Input Wattage (W): 39
 Total Output Wattage (W): 35.4
 Dimming: Non-Dimmable
 Driver Included: Yes
 Driver Location: Integrated
 Driver Type: Constant Current - Universal
 Driver Class: Class 2
 Input Voltage (V): 120 - 277

LED

Color Temperature (°K): 2700 / 3000 / 3500 / 4000
 Max. Delivered Lumen (lm): 2776 / 2904 / 3012 / 3080
 Nominal Lumen (lm): 3878 / 4056 / 4206 / 4301
 CRI: >90 CRI
 Lamp Life (hrs): 50000

OPTICAL

Beam Angle: 40 / 52

RATINGS AND CERTIFICATIONS

Certified By: Certified for North American Standards
 IP rating: IP20

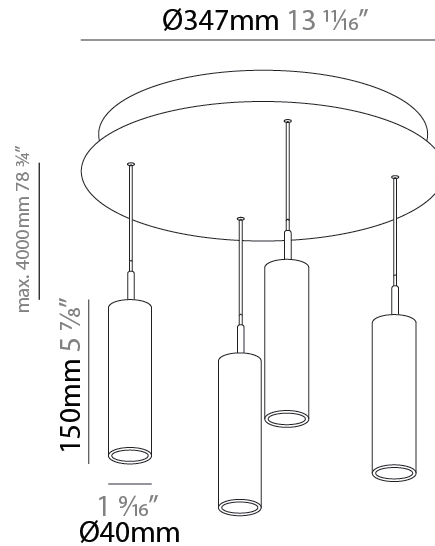

G-MINI ROUND HANGOVER SUSPENSION

A300632-

PROJECT	_____
TYPE	_____
SPECIFIER	_____
QUANTITY	_____
DATE	_____



A

G-MINI ROUND HANGOVER SUSPENSION

A300633-

base number LED Dimming Finishes (Diamond) Finishes (Triangle) Finishes (Circle) Finish Options Shine Ring Beam Angle Options Cable Options

- To build a product code in our configurator select the specify button on the base model # product page
- To build a manual product code on this datasheet choose from the options listed below in blue font and add the suffix to the base model #

GENERAL

Series: G-Mini Round
 Subseries: G-Mini Round Hangover
 Partner: Prolicht
 Division: Architectural
 Installation: Suspension
 Product Type: Clusters
 Mounting Location: Ceiling
 Light Distribution: Direct

PHYSICAL

Shape: Cylinder
 Diameter (mm): 347
 Diameter (in): 13 11/16
 Height (mm): 300
 Height (in): 11 13/16
 Fixture Finish: SSR / BKV / CWI / CRY / HAB / UFT / ITA / RUA / FTG / MYG / LOD / PUS / FRO / FUP / KIA / POP / BLS / SPG / MEY / GOH / CHC / COM / ABZ / JAG / OBR / MOS / ROR
 Accent Finish: NOF / COP / MIR / SSS
 Fixture Material: Extruded Aluminum / Steel
 Cable Details: 2000mm/78 3/4" / 4000mm/157 1/2" - Cable, Black, Green, Orange, Red, White

ELECTRICAL

Lamp Type: LED (Zhaga Standard)
 Input Wattage (W): 39
 Total Output Wattage (W): 35.4
 Dimming: Non-Dimmable
 Driver Included: Yes
 Driver Location: Integrated
 Driver Type: Constant Current - Universal
 Driver Class: Class 2
 Input Voltage (V): 120 - 277

LED

Color Temperature (°K): 2700 / 3000 / 3500 / 4000
 Max. Delivered Lumen (lm): 2776 / 2904 / 3012 / 3080
 Nominal Lumen (lm): 3878 / 4056 / 4206 / 4301
 CRI: >90 CRI
 Lamp Life (hrs): 50000

OPTICAL

Beam Angle: 40 / 52

RATINGS AND CERTIFICATIONS

Certified By: Certified for North American Standards
 IP rating: IP20

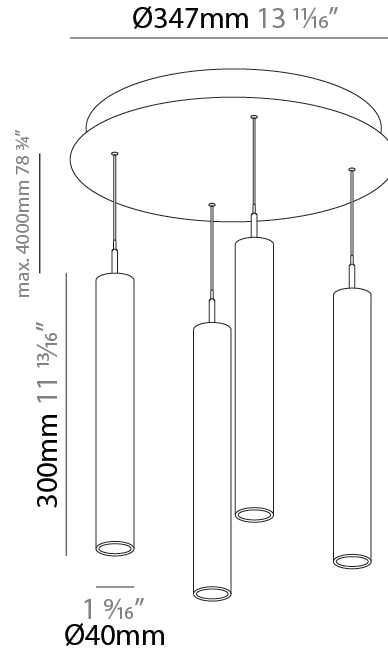
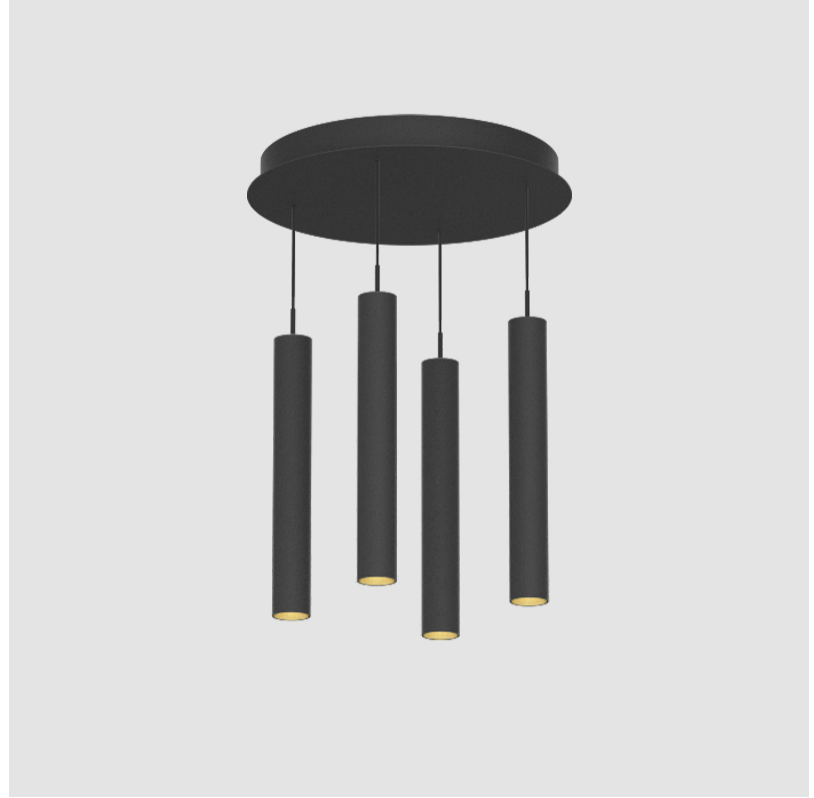

G-MINI ROUND HANGOVER SUSPENSION

A300633-

PROJECT	_____
TYPE	_____
SPECIFIER	_____
QUANTITY	_____
DATE	_____



A

G-MINI ROUND HANGOVER SUSPENSION

A300634-

base number LED Dimming Finishes (Diamond) Finishes (Triangle) Finishes (Circle) Finish Options Shine Ring Beam Angle Options Cable Options

- To build a product code in our configurator select the specify button on the base model # product page
- To build a manual product code on this datasheet choose from the options listed below in blue font and add the suffix to the base model #

GENERAL

Series: G-Mini Round
 Subseries: G-Mini Round Hangover
 Partner: Prolicht
 Division: Architectural
 Installation: Suspension
 Product Type: Clusters
 Mounting Location: Ceiling
 Light Distribution: Direct

PHYSICAL

Shape: Cylinder
 Diameter (mm): 347
 Diameter (in): 13 11/16
 Height (mm): 450
 Height (in): 17 11/16
 Fixture Finish: SSR / BKV / CWI / CRY / HAB / UFT / ITA / RUA / FTG / MYG / LOD / PUS / FRO / FUP / KIA / POP / BLS / SPG / MEY / GOH / CHC / COM / ABZ / JAG / OBR / MOS / ROR
 Accent Finish: NOF / COP / MIR / SSS
 Fixture Material: Extruded Aluminum / Steel
 Cable Details: 2000mm/78 3/4" / 4000mm/157 1/2" - Cable, Black, Green, Orange, Red, White

ELECTRICAL

Lamp Type: LED (Zhaga Standard)
 Input Wattage (W): 39
 Total Output Wattage (W): 35.4
 Dimming: Non-Dimmable
 Driver Included: Yes
 Driver Location: Integrated
 Driver Type: Constant Current - Universal
 Driver Class: Class 2
 Input Voltage (V): 120 - 277

LED

Color Temperature (°K): 2700 / 3000 / 3500 / 4000
 Max. Delivered Lumen (lm): 2776 / 2904 / 3012 / 3080
 Nominal Lumen (lm): 1840 / 1949 / 2057 / 2112
 CRI: >90 CRI
 Lamp Life (hrs): 50000

OPTICAL

Beam Angle: 40 / 52

RATINGS AND CERTIFICATIONS

Certified By: Certified for North American Standards
 IP rating: IP20



G-MINI ROUND HANGOVER SUSPENSION

A300634-

PROJECT
TYPE
SPECIFIER
QUANTITY
DATE



A

G-MINI ROUND HANGOVER SUSPENSION

A300635-

base number LED Dimming Finishes (Diamond) Finishes (Triangle) Finishes (Circle) Finish Options Shine Ring Beam Angle Options Cable Options

1. To build a product code in our configurator select the specify button on the base model # product page
2. To build a manual product code on this datasheet choose from the options listed below in blue font and add the suffix to the base model #

GENERAL

Series: G-Mini Round
 Subseries: G-Mini Round Hangover
 Partner: Prolicht
 Division: Architectural
 Installation: Suspension
 Product Type: Clusters
 Mounting Location: Ceiling
 Light Distribution: Direct

PHYSICAL

Shape: Cylinder
 Diameter (mm): 75
 Diameter (in): 2 ¹⁵/₁₆
 Length (mm): 1200
 Length (in): 47 ¹/₄
 Height (mm): 150
 Height (in): 5 ⁷/₈

Diffuser: Shine Ring - NOR / OPL / YEL / ORA / RED / BLU / GRN
 Fixture Finish: SSR / BKV / CWI / CRY / HAB / UFT / ITA / RUA / FTG / MYG / LOD / PUS / FRO / FUP / KIA / POP / BLS / SPG / MEY / GOH / CHC / COM / ABZ / JAG / OBR / MOS / ROR
 Accent Finish: NOF / COP / MIR / SSS
 Fixture Material: Extruded Aluminum / Steel
 Cable Details: 2000mm/78 3/4" / 4000mm/157 1/2" - Cable, Black, Green, Orange, Red, White

ELECTRICAL

Lamp Type: LED (Zhaga Standard)
 Input Wattage (W): 26
 Total Output Wattage (W): 23.7
 Dimming: Non-Dimmable
 Driver Included: Yes
 Driver Location: Integrated
 Driver Type: Constant Current - Universal
 Driver Class: Class 2
 Input Voltage (V): 120 - 277

LED

Color Temperature (°K): 2700 / 3000 / 3500 / 4000
 Max. Delivered Lumen (lm): 1557 / 1649 / 1740 / 1787
 Nominal Lumen (lm): 1840 / 1949 / 2057 / 2112
 CRI: >90 CRI
 Lamp Life (hrs): 50000

OPTICAL

Beam Angle: 6 / 22 / 38

RATINGS AND CERTIFICATIONS

Certified By: Certified for North American Standards
 IP rating: IP20

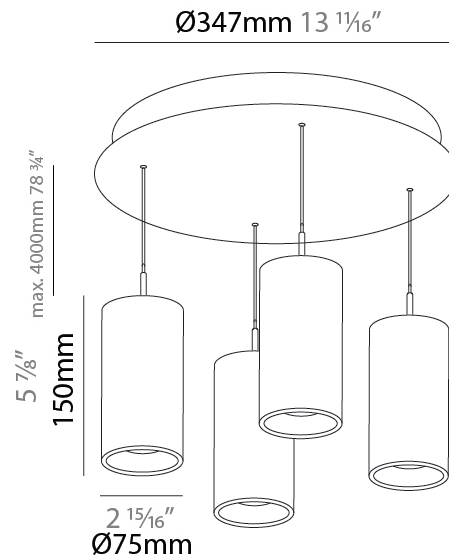

G-MINI ROUND HANGOVER SUSPENSION

A300635-

PROJECT	_____
TYPE	_____
SPECIFIER	_____
QUANTITY	_____
DATE	_____



A

PROJECT	_____
TYPE	_____
SPECIFIER	_____
QUANTITY	_____
DATE	_____

G-MINI ROUND HANGOVER SUSPENSION

A300636-

base number	LED Dimming	Finishes (Diamond)	Finishes (Triangle)	Finishes (Circle)	Finish Options	Shine Ring	Beam Angle Options	Cable Options
-------------	-------------	--------------------	---------------------	-------------------	----------------	------------	--------------------	---------------

- To build a product code in our configurator select the specify button on the base model # product page
- To build a manual product code on this datasheet choose from the options listed below in blue font and add the suffix to the base model #

GENERAL

Series: G-Mini Round
Subseries: G-Mini Round Hangover
Partner: Prolicht
Division: Architectural
Installation: Suspension
Product Type: Clusters
Mounting Location: Ceiling
Light Distribution: Direct

PHYSICAL

Shape: Cylinder
Diameter (mm): 75
Diameter (in): 2 ¹⁵ / ₁₆
Length (mm): 1200
Length (in): 47 ¹ / ₄
Height (mm): 150
Height (in): 5 ⁷ / ₈
Diffuser: Shine Ring - NOR / OPL / YEL / ORA / RED / BLU / GRN
Fixture Finish: SSR / BKV / CWI / CRY / HAB / UFT / ITA / RUA / FTG / MYG / LOD / PUS / FRO / FUP / KIA / POP / BLS / SPG / MEY / GOH / CHC / COM / ABZ / JAG / OBR / MOS / ROR
Accent Finish: NOF / COP / MIR / SSS
Fixture Material: Extruded Aluminum / Steel
Cable Details: 2000mm/78 3/4" / 4000mm/157 1/2" - Cable, Black, Green, Orange, Red, White

ELECTRICAL

Lamp Type: LED (Zhaga Standard)
Input Wattage (W): 38
Total Output Wattage (W): 34.5
Dimming: Non-Dimmable
Driver Included: Yes
Driver Location: Integrated
Driver Type: Constant Current - Universal
Driver Class: Class 2
Input Voltage (V): 120 - 277

LED

Color Temperature (°K): 2700 / 3000 / 3500 / 4000
Max. Delivered Lumen (lm): Max 3171
Nominal Lumen (lm): Max 4231
CRI: >90 CRI
Lamp Life (hrs): 50000

OPTICAL

Beam Angle: 6 / 22 / 38

RATINGS AND CERTIFICATIONS

Certified By: Certified for North American Standards
IP rating: IP20

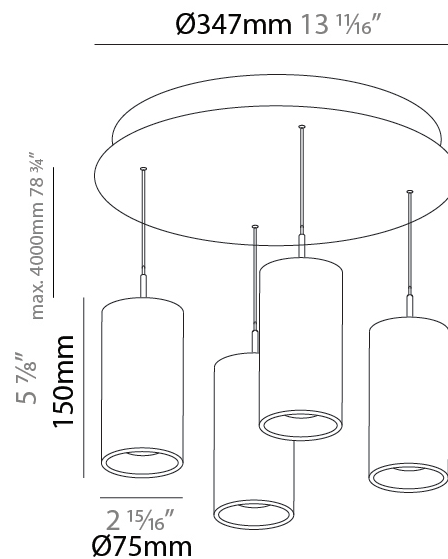

G-MINI ROUND HANGOVER SUSPENSION

A300636-

PROJECT	_____
TYPE	_____
SPECIFIER	_____
QUANTITY	_____
DATE	_____



A

G-MINI ROUND

COLOR FINISH CHART

Fixture Finish

Sparkling Silver - 01 (SSR)



Black Velvet - 02 (BKV)



Crystal White - 03 (CWI)



Creamy - 04 (CRY)



Hampton Bay - 05 (HAB)



Urban Forest - 07 (UFT)



In the Army - 08 (ITA)



Rusty Angel - 09 (RUA)



Fade to Gray - 12 (FTG)



Mysterious Gray - 13 (MYG)

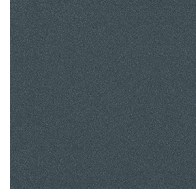

Lost Dream - 15 (LOD)

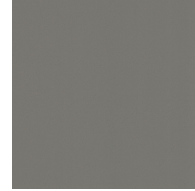

Purple Sky - 16 (PUS)



Fresh Oh - 17 (FRO)

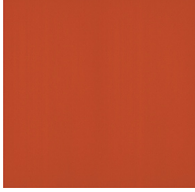

Funky P. - 18 (FUP)



Kissing Aphrodite - 19 (KIA)



Poseidon's Paradise - 20 (POP)

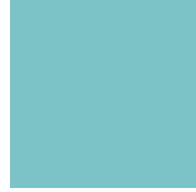

Blue Sky - 21 (BLS)



Spring Green - 22 (SPG)

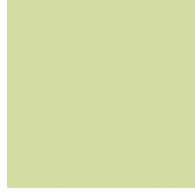

Mellow Yellow - 23 (MEY)

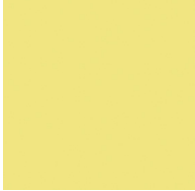

Golden Heart - 24 (GOH)

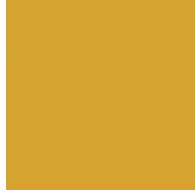

Champagne Cream - 26 (CHC)



Copper Mine - 27 (COM)



Ancient Bronze - 28 (ABZ)



Jazz Gold - 29 (JAG)



Olive Breeze - 30 (OBR)



Moonlight Silver - 31 (MOS)



Rosewood Red - 32 (ROR)



G-MINI ROUND HANGOVER SUSPENSION

COLOR FINISH CHART

PROJECT _____

TYPE _____

SPECIFIER _____

QUANTITY _____

DATE _____

Accent Finish

Copper - 51 (COP)

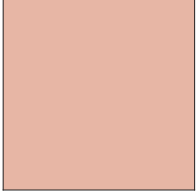

Mirror - 53 (MIR)



Digital: Not all screens are calibrated the same, and therefore, colors will appear differently between screens.

Physical: When texture is involved, there will be variations in color, character and tone within a product series and between product families.

Champagne Cream, Copper Mine, Ancient Bronze + Jazz Gold: These finishes have slight fading from specific powder coating production. Each luminaire will slightly vary.



LEGEND

	floor-mounted		pivotable		special LED (upon request) RGB, RGBW, tunable, gold+, meat+, art+, fashion+
	wall and ceiling: recessed and surface mounted		rotating		warm dim / natural dimming LED
	ceiling-mounted and wall-mounted		illuminate tilted		rechargeable battery powered
	wall-mounted		color of suspension cable		fixture with natural vivid LED (upon request)
	omni-directional light distribution		length of suspension cable		color rendering index
	direct light distribution		reflector degree selection		color temperature
	direct/indirect light distribution		super spot		lumen (luminous flux)
	indirect light distribution		lens		efficacy (lumens per watt)
	asymmetric light distribution		lens pack		Unified Glare Rating (UGR) range from 5-40
	aura light distribution		shine ring		marine grade (AISI 316 stainless steel)
	round wall or ceiling cut-out		integrated shine ring with diffuser		walk on
	square wall or ceiling cut-out		free individual colors 01-29		drive on
	the supplied jig specifies the cutout dimensions		individual colors: 00 (free of charge), 01-25 (extra charge)		Dark Sky Compliance
	minimum distance (meters) lamp - object		luminaire part to be colored (F1)		Americans with Disabilities Act (less than 4" off the wall located between 27"-84" from floor)
	recessed depth		luminaire part to be colored (F2)		lamp protected against explosion
	ceiling thickness in mm		luminaire part to be colored (F3)		blown glass using traditional methods by master glass blower
	ceiling thickness selection		luminaire part to be colored (F4)		acoustic material
	dimmable DP (phase), DV (0-10V), DD (dali), DS (step-dim)		luminaire part to be colored (F5)		protection class I, protection insulation
	included or excluded LED driver/transformer/control gear		color of 3-circuit adaptor		protection class II, protection insulation
	separately switchable		indirect diffuser		ETL Certified to UL and CSA Standards
	sensor		direct diffuser		UL Certified to UL and CSA Standards
	remote control		ball-proof (upon request)		CSA Certified to UL and CSA Standards
	available upon request		accessory		Certified for North American Standards

IP RATING

	protected against ingress of solid bodies greater than 12.5mm (finger)
	protected against ingress of solid bodies greater than 2.5mm protected against sprays of water up to 60 degrees from the vertical (rain)
	protected against ingress of solid bodies greater than 1mm (wire) no protection against the ingress of moisture
	protected against ingress of solid bodies greater than 1mm (wire) protected against sprays of water up to 60 degrees from the vertical (rain)
	protected against ingress of solid bodies greater than 1mm (wire) protected against water splashed from all directions
	protected against limited ingress of dust (wet rooms/covered outdoor areas) protected against water splashed from all directions
	protected against ingress of dust protected against jets of water
	protected against ingress of dust protected against powerful jets of water or heavy seas
	protected against ingress of dust protected against immersion of water between 15cm - 1m for 30 minutes
	protected against ingress of dust protected against immersion of water under pressure for long periods

IK RATING

	protected against 0.14 joules impact (equivalent to 0.25kg mass dropped from 56mm above the surface)
	protected against 0.2 joules impact (equivalent to 0.25kg mass dropped from 80mm above the surface)
	protected against 0.35 joules impact (equivalent to 0.25kg mass dropped from 140mm above the surface)
	protected against 0.5 joules impact (equivalent to 0.25kg mass dropped from 200mm above the surface)
	protected against 0.7 joules impact (equivalent to 0.25kg mass dropped from 280mm above the surface)
	protected against 1 joules impact (equivalent to 0.25kg mass dropped from 400mm above the surface)
	protected against 2 joules impact (equivalent to 0.5kg mass dropped from 400mm above the surface)
	protected against 5 joules impact (equivalent to 1.7kg mass dropped from 300mm above the surface)
	protected against 10 joules impact (equivalent to 5.0kg mass dropped from 200mm above the surface)
	protected against 20 joules impact (equivalent to 5.0kg mass dropped from 400mm above the surface)